

Compound Group

- 13 Compound
- 35 Compound
- 07 Compound
- 05 Compound
- 03 Compound
- 93 Compound
- 83 Compound

13

**13 Compound** is a new generation of ultimate high bite—high friction. 13 compound has been developed with increased bite, modulation, with superior disc conditioning and release characteristics for exceptional control. Ultra smooth and great for tracks with high grip or high downforce cars. It is the ultimate combination of high bite and infinite control.

**Typical Applications;** Ideal use for sprint and severe applications, heavy, high speed applications or high downforce cars where high bite at the first 3rd of the stop is desired. 13's wear is on a par with PFC's legendary 01 compound and will operate at higher temperatures if called to as .13 has a very high threshold for fade resistance. Out of all the high bite, high torque pads in the market 13 has shown to have one of the lowest taper wear in a properly designed race caliper.

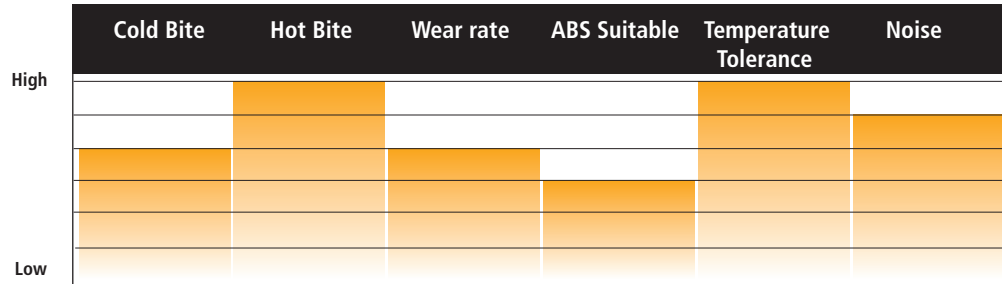

Sprint race, & rally, with competition tyres

Compound Group

- 11 Compound
- 01 Compound
- 99 Compound
- 90 Compound

11

**11 Compound** is a new generation sprint and medium distance friction providing the ultimate in control, with superior disc conditioning. 11 compound was developed from the 01 compound with improved bite, modulation, and release characteristics. It is ultra smooth and developed to reduce wheel locking at the end of a stop. For many applications, 11 will replace the venerable 01 compound.

**Typical Applications;** Ideal for use at medium-low grip venues where control and modulation is at a premium. Also in racing applications where ABS systems are used, .11 can be used in a large spectrum of temperature ranges. 11's wear is par with PFC's legendary 01 compound showing virtually zero taper wear when raced in a properly designed race caliper.

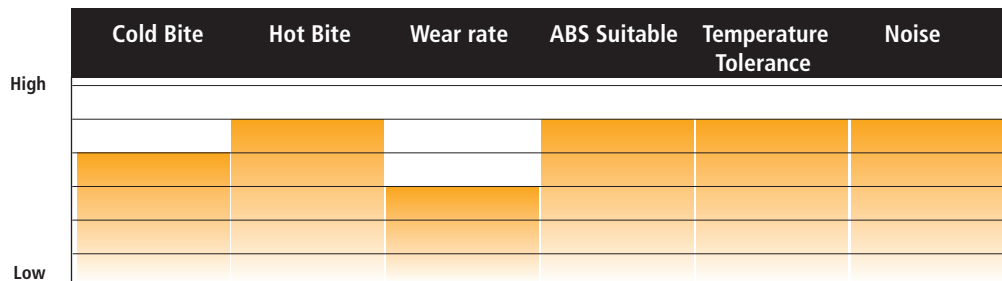

Race & track day with competition / high performance tyres

Compound Group

- 08 Compound
- 06 Compound
- 97 Compound

08

**08 compound** has gained immediate favour in Endurance Sportscar and GT racing and also in endurance production car racing due to its performance in applications where smooth initial bite is a must. 08 has a slight friction rise with temperature with excellent release and modulation characteristics. Very low abraded disc wear with a fine grey slate like disc finish, similar to 01. Despite its considerable performance, 08 wears the longest of all PFC pads and easily matches wear of the other competitors with much higher bite. If temperature isn't an issue, 08 can be replaced with 12 compound. Typical Applications; Endurance, GT and endurance production car racing, trackday



High temp endurance race applications & track day with high performance tyres

### Compound Group

12 Compound  
06 Compound  
97 Compound

# 12

**12 Compound** is a new generation endurance friction—excellent bite with 24 hour durability in its DNA and superior disc conditioning. 12 compound was developed from 08 Compound with improved wear, modulation, and release characteristics. It provides the ultimate in low wear. The PFC .12 Compound won in its debut race the 2013 Daytona 24hr overall winner. 12 compounds wear is lower than 08 when high temperatures is not an issue.

**Typical Applications;** Ideal use for endurance when low wear is at a premium. Also race applications where ABS systems are used. 12's wear is at its optimum when disc temperature paints show 450-500c operating temperatures but will operate at higher temperatures if called to. Virtually zero taper wear when raced in a properly designed race caliper.

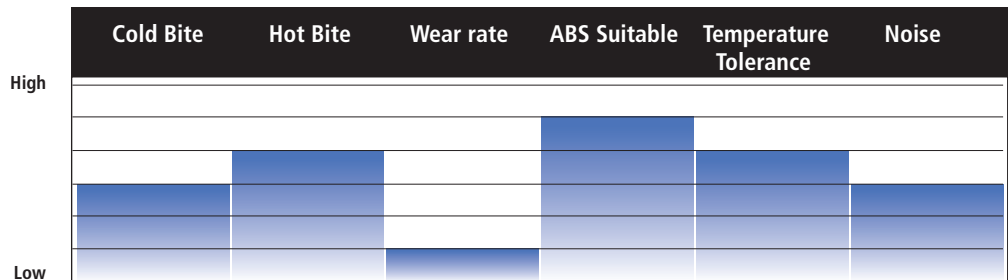

Low temp endurance race applications & track day with high performance tyres

### Compound Group

14 Compound  
81 Compound  
80 Compound

# 14

**14 Compound;** Lower friction and slightly less bite than the majority of PFC Race compounds. 14 compound provides high thermal stability and consistency.

**Typical Applications;** Suitable for low grip applications and surfaces with treaded or street tyres.

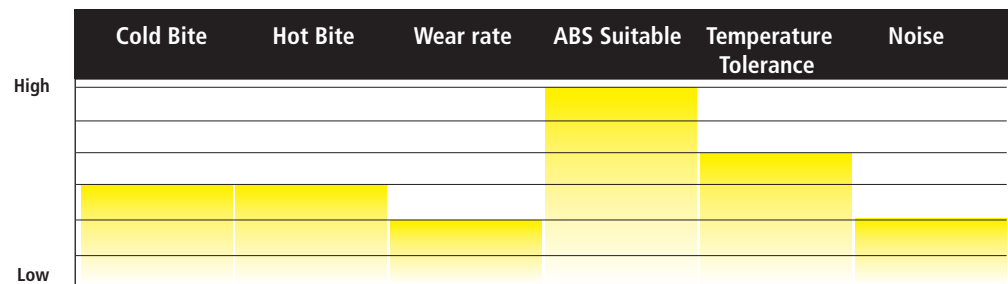

Low grip & Performance road applications

### Compound Group

Z-Rate  
Compound  
.11 Compound  
.10 Compound  
.38 Compound

# Z-Rated

**Z-Rated;** This compound has been developed for fast road / track day applications. It provides more stopping power and increased fade resistance over the std OE materials but retains the good qualities of the road pad i.e., low dusting and noise along with low wear rate.

**Typical Applications;** This compound can be used in OE calipers or aftermarket brake kits in applications where an increase in performance is required over the standard OE friction material.

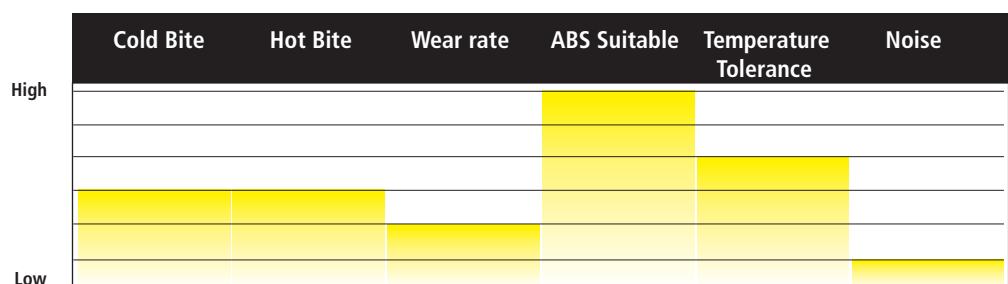

Performance road with noise suppression technologies

## Brake Pad Applications

Make/Year	Model	Application	Front	Rear
<b>ASTON MARTIN</b>				
96-97	DB7	Coupe and Convertible	0412	-
99-04	DB7	Brembo Caliper	7780	-
04-	DB9	Brembo caliper	1001 / 7781	0592 / 1053
01-	Vanquish 5.9, 6.0 V12	Brembo Caliper	7780	0592 / 1053
93-96	Vantage	AP Caliper	7767	-
04-	Vantage	Brembo caliper	1001 / 7781	0592 / 1053
07-	N24	Brembo caliper	1001 / 7781	0592 / 1053
<b>AUDI</b>				
96-99	S3	RS	1001 / 7781	-
96-99	A3	1.8 20v Turbo	0687	0340
95-00	A4	1.8 20v	0687	0340
98-	TT	1.8 Turbo	0687	0340
98-	TT	RS	1001 / 7781	0340
06-08	RS4 (B7)	Brembo Caliper	7856	-
02-04	RS6 (C5)	Brembo Caliper	7856	-
07-	R8	Brembo Caliper	7856	7780
94-97	A6	A6, Quattro, Avant	0687	-
02-	S8	Brembo Caliper	0594	7780
<b>ALFA ROMEO</b>				
03-	156 3.2 GTA	Brembo Caliper	1001 / 7781	-
98-	166 2.0 V6	Brembo Caliper	1001 / 7781	-
03-	166 2.4 JTD	Brembo Caliper	1001 / 7781	-
98-00	166 2.5 24v	Brembo Caliper	1001 / 7781	-
98-00	166 3.0 24v	Brembo Caliper	1001 / 7781	-
03-	166 3.2 24v	Brembo Caliper	1001 / 7781	-
05-	Brera	Brembo Caliper	1001 / 7781	-
<b>BMW</b>				
08-13	135i	E82	1371	1372
10-	1M	E82	0918	0919
85-93	3 Series	E30	0278	0279
86-92	M3	E30	0395	0396
92-99	M3	E36, M3 Evo	0394	0396
01-	M3	E46 (inc CSL)	0394	0548
07-	M3	E92	0918	0919
88-94	M5	E34	0394	0396
08 -	1 Series	E87	0558	-
01-04	3 Series 330i	E46	1061	-
75-82	3 Series	E21	0174	-
90-99	3 Series	E36	0558	0396
98-	3 Series	E46	0558	0396
81-86	5 Series	E28	0395	-
88-95	5 Series	E34	0394	0396
95-	5 Series	E39 not M5	0394	0396
82-89	6 Series	E24	0394	-
2004 -	6 Series	E63, 635 / E64, 630,645,650	0918	0919
86-94	7 Series	E32	0395	0396
94-01	7 Series	E38	0639 / 0960	0548
94-	8 Series	E31	0639 / 0960	0548
97-	Z3	1.8, 2.8	0558	0396
97-	Z3	Coupe, Roadster, 3.2 M	0394	0396
06 -	Z4	Z4 M Coupe	0394	0548
03 -	Z4	E85 / 86	0558	0396
02 -	<b>MINI</b> Cooper	Cooper / Cooper S	0939	0940
-08	<b>MINI</b> Cooper JCW	John Cooper Works		1060
<b>CHEVROLET</b>				
66-82	Corvette, Stingray	4 piston caliper	0008	0008
68-69	Camaro	Z28 (4 piston caliper)	0008	0008
05-	Corvette C6	Excluding ZO6	0731	0732
97-05	Corvette C5	Including ZO6	0731	0732
<b>CATERHAM</b>				
	Seven Range	STD 2 piston Caliper	0044	0382
	Seven Range	AP7600 caliper	7834	0382



Make/Year	Model	Application	Front	Rear
<b>CITROEN</b>				
03-	C2 Sport	Brembo Front Caliper	1001 / 7781	0340
<b>DODGE</b>				
92-02	Viper	Brembo Caliper	0592	0491
03-	Viper SRT-10	Brembo Caliper	7780	7780
<p>OFFICIAL TECHNICAL PARTNER OF</p> 				
<b>FERRARI</b>				
64-66	330 GT	4	0174/7824	-
68-76	365 GTC / GTS	4.4	0174/7824	0252
69-73	246 GT	2.4	0174/7824	0031
73-76	308 GTS / GTB	All	0395	-
73-77	308 GT4 / GTB	2.9	0174/7824	0031
81-89	Mondial	2.9 / 3.2	0395	-
85-89	GTB	2.0	0395	-
85-89	GTS	2.0	0395	-
86-89	328 GTB / GTS	3.2	0395	-
88-92	F40	All	7780	7780
89-93	Mondial	3.4	0345	-
89-95	348 TB / TS	3.4	0345	0345
92-96	512TR (48v)	4.9	0345	0345
92-96	512TR (option)	4.9	7780	0345
93-	355 Sedantta / GTS / Spider	3.5	0345	0345
93-	456 GT	All	0639/0960	0345
93-	355 Challenge	Spec	7700 (25mm)	7700 (25mm)
94-95	F512M (48v)	4.9	0345	0345
95-97	F50	All	7780	0592/1053
96-	550 Maranello	All	0639/0960	0345
99-	360 Challenge	Spec	7770 (20mm)	7700 (16mm)
99-	360	All	0592/1053	0592/1053
04	612	5.7	1001/7781	0592/1053
02-	575M	5.7	0639/0960	0345
05-	F430	All	0592/1053	0592/1053
<b>FORD</b>				
91-97	Escort	Cosworth 16v 4x4	7760	0382
02 - 04	Focus Mk1	2.0 RS Brembo Caliper	0592/1053	-
05 -	Focus Mk2	2.5 ST	1305	-
89-93	Sierra	Cosworth 16v 4x4	7760	0382
95-04	Mustang	Cobra	0412	0627
87-93	Mustang	V8	0431	-
07-	Mustang	GT500	7780	1082
<b>HONDA</b>				
93-00	Civic Coupe	Exc. EX & Si models	0273	0503
88-89	Civic CRX	Si	0273	0503
88-91	Civic CRX	DX	0273	0503
91- 01	Civic	EG9,EJ1,EJ8,ECT,ESi,VRI	0621	-
93-95	Civic Del Sol	S, Si w/o ABS	0273	-
99-	Civic	Type-R	0829	0537
99-	S2000	2.0 16v	0829	0537
02-	Integra	Type-R DC05	0639/0960	0537
<b>JAGUAR</b>				
98-02	XJ8		0394	-
95-96	XJ12	ATE caliper	0394	0396
95-02	XJR	4.0 Supercharged,Brembo caliper	7780	-
99-	XJR		0394	0396
89-93	XJR-S	6.0	0394	0396
91-94	XJS	4.0, 5.3	0394	0396
97-03	XK8	4.0	0394	0396
98-04	XKR	Brembo caliper	7780	-
<b>LAMBORGHINI</b>				
90-96	Diablo	Brembo caliper	0639 / 0960	0345
97-03	Diablo	Brembo caliper	7780	-
01-	Murciélago	Brembo caliper	7780	7780
04-	Gallardo	Brembo caliper	7856	7780

Make/Year	Model	Application	Front	Rear
<b>LANCIA</b>				
87-89	Delta	Integrale Turbo	0590	-
89-96	Delta	Integrale Turbo	0590	-
91-95	Delta	Integrale Turbo Evo	0592	0340
<b>LEXUS</b>				
00-05	IS300	3.0i V6	0619	0771
93-05	GS300	3.0i V8	0619	0771
98-00	GS400	4.0i V8	0619	0771
01-05	GS430	4.3i V8	0619	0771
96-97	LX450	4.5i V8	0502	-
02-09	SC430	4.3i V8	0619	0771
<b>LOTUS</b>				
96-	Elise	1.8	7824	0491
99-	Elise	1.8 VVC	7824	0491
	Elise (upgrade)	1.8	7745	7824
03-	Exige	1.8, 2.2i	7824	0491
06-	Exige	Sport Cup (4 piston)	7834	0491
75-86	Esprit 2.2	S1, S2, S3	7824	-
<b>MARCOS</b>				
97-	GTS	2.0	7767	0382
94-	LM	4.0, 6.0	7767	0382
97-	Mantis	4.6	7767	0382
92-	Mantra	2.0	0345	0382
92-	Mantra	2.0 Turbo	7767	0382
92-	Mantra	4.0, 4.5	7767	0382
99-	Mantaray	4.0, 4.6	7767	0382
<b>MCLAREN</b>				
92-98	F1	6.1	7780	7780
<b>MASERATI</b>				
89-93	Ghibli	2.8	0395	0031
93-	Ghibli	2.8	0639 / 0960	0031
87-	430	3.8 Bi Turbo	0395	0031
99-	3200GT	3.2 V8 Bi Turbo	0639 / 0960	0345
02-	Spyder	V8 4.2	0639 / 0960	0345
<b>MAZDA</b>				
85-96	RX-7	Coupe	0463	0482
94-00	MX5	Roadster	0635	0636
06-	MX5	Roadster	1179	1180
<b>MERCEDES</b>				
03	S55	AMG	-	0984
04-	SLR55	AMG	-	0984
04-	SLR 55	AMG	9195	0984
<b>MINI (Classic)</b>				
63-71	Cooper, S	2 Piston Caliper	7720	-
		4 Piston Caliper	7765	-
<b>MITSUBISHI</b>				
94-00	FTO		0530	0532
92-	3000GT, GTO	3.0 Twin Turbo	0460	0630
90-	Galant	VR4	0530	-
92-95	Evo III	AKE caliper	0530	-
96-08	EVO V,VI,VII,VIII,IX	Brembo caliper	1001 / 7781	0109
96-	EVO V,VI,VII,VIII,IX	AKE caliper	0530	0532
09-	EVO X	Brembo caliper	1001 / 7781	1368
92-96	3000 GTO	AKE caliper	0530	-
<b>MORGAN</b>				
66-94	4/4	1.6	0051	-
85-94	Plus 4	2.0	0051	-
83-90	Plus 8	3.5/ 3.5i	7824	-
00-	Aero 8	4.4	7869	7720



Make/Year	Model	Application	Front	Rear
<b>NISSAN</b>				
94-01	200SX	2.0 Turbo	0460	-
90-94	300ZX	3.0 Twin Turbo	0460	-
02-	350Z	Brembo caliper	0639 / 0960	0109
09-	370Z	Brembo caliper	1346	1347
93-94	Skyline R32 GT-R	Brembo caliper	0639 / 0960	0109
95-98	Skyline R33 GT-R	Brembo Caliper	0639 / 0960	0109
99-	Skyline R34 GT-R	Brembo Caliper	0639 / 0960	0109
08-	R35 GT-R	Brembo Caliper	4362	7780

<b>NOBLE</b>				
99-02	M12 GTO	2.6 Twin Turbo	7767	7745
02-	M12 GTO	3.0 Twin Turbo	7869	-
04-	M14	3.0 Twin Turbo	7869	-

## PORSCHE

OFFICIAL TECHNICAL PARTNER OF



63-65	356	C	0031	-
72-83	911	2.2 / 2.3 / 2.7 / 3.2	0045	0031
77-90	911	3.3 SC Turbo, Turbo Sport	0345	0345
79-87	924	2.0	0252	-
78-85	928	4.5	0252	-
80-85	928	S	0395	-
81-85	928	4.7	0253	-
85-95	928	S & S4 & GT	0447	0345
91-95	928	5.4 GTS 32V	0594	0345
85-87	944	2.5 Turbo	0345	0345
87-91	944	2.5 Turbo	0447	0345
88-91	944	2.7 & 3.0 S2	0345	0345
87-91	959	2.8	0594	0594
88-91	964	C2 3.6	0345	-
91-94	964	C2 3.6	0345	0345
88-94	964	3.6 C4	0345	0345
91-93	964	3.6 Carrera RS	0447	0345
88-91	964	3.3 Turbo & Turbo S	0447	0345
91-93	964	3.3/3.6 Turbo/Turbo S	0594	0345
91-95	968	3.0 Coupe	0345	0345
91-95	968	3.0 Coupe Sport	0447	0345
93-95	968	3.0 Coupe Turbo S	0594	0345
12-	981	Boxster S	1389	0776
13-	981c	Cayman S steel brakes	1389	0738
96-05	986	Boxster	0737	0738
99-05	986	Boxster S	0776	0738
06-09	987c	Cayman S	0737	0738
05-12	987	Boxster	0737	0738
05-12	987	Boxster S	0776	0738
05-12	987	Boxster S ceramic brakes	0991	0776
09-12	987c	Cayman	0776	0738
09-12	987c	Cayman S	0776	0738
11-	991	3.4 C steel brakes	1389	1390
13-	991	GT3 / Turbo / Turbo S steel brakes	7721	7727
13-	991	Cup	7968	7969
93-97	993	3.6 Carrera & C4	0447	0345
95-97	993	3.8 Carrera & C4	0447	0345
95-97	993	3.6 Turbo & Turbo GT2	0594	0447
95-97	993	3.8 Carrera RS & RSR	0594	0447
95-97	993	GT2 & RSR (380 disc)	0594 (25mm)	0447
97-05	996	3.4 C & 3.6	0776	0738
01-	996	C4 S	7818	0776
97-98	996	3.4 C Super-Cup	0594	0776
99-01	996	3.4 C Super-Cup	7818	0776
00-05	996	GT3 R & GT3 RS	0594 (25mm)	7700 (25mm)
99-01	996	GT3 & 996 Turbo	7818	0776
02-	996	Turbo	7818	0776
02-	996	GT3	7819* / 0991	0776
02-	996	GT3 Super-Cup	7819*	0776
02-	996	GT2	7819* / 0991	0776
04-	997	Carrera GT	0991	0776
05-08	997	3.6 C / 3,6 C4	0776	0738
08-	997	3.6 C / 3,6 C4	1389	1299
05-08	997	3.8 C S / 3,8 C4 S	7818	0776

\* 7819 use on 350mm PFC discs

Make/Year	Model	Application	Front	Rear
<b>PORSCHE</b>				
08-	997	3.8 C S / 3,8 C4 S	7818	1299
09-	997	3.8 GTS	7818	0776
05-	997	all models with PCCB	0991	1299
06-	997	GT3, GT3 RS, Turbo, GT2	0991 / 7819*	1299
05-	997	GT3 Cup	7819*	1299
07-	997	GT3 Cup S / Grand Am	7797 (22mm)	7700 (20mm)
07-	997	GT3R / RSR	7797 (29mm)	7700 (25mm)
* 7819 use on 350mm PFC discs				
<b>RENAULT</b>				
85-90	Alpine	GTA	0292	0516
86-91	R5	GT Turbo	0292	0516
91-98	Clio	1.8 & 2.0 16v Williams	0292	0516
99-	Clio	2.0 16v	0590	0516
00-02	Clio	3.0 V6	0592 / 1053	0592 / 1053
02-04	Clio	3.0 V6 Turbo Sport	7869	0592 / 1053
00-	Clio	RS (II) 2.0	0590	0516
06-	Clio	RS (III) 2.0 16v	7871	0340
96-99	Megane	2.0 16v Sport	0590	0516
04-	Megane / Clio 197	2 RS	7871	0340
95-97	Sport Spyder		0590	
10-	Megane III RS	Renaultsport 250	1001 / 7781	0340
<b>SEAT</b>				
01-	Ibiza	Turbo R	0592 / 1053	0340
00-	Leon	1.8 20v Turbo Cupra / Sport	0687	0340
02-	Leon	1.8 Cupra R	0592	0340
99-	Toledo	2.3 V5	0687	0340
<b>SKODA</b>				
00-	Fabia	2.0	0687	0340
97-	Octavia	1.8 20v Turbo	0687	0340
01-	Octavia	1.8 Turbo RS	0687	0340
<b>SUBARU</b>				
98-	Impreza	Turbo	0460	0461
01-	Impreza WRX	Sti Brembo Caliper	1001 / 7781	0109
	Impreza	Prodrive P1	0460	0461
	Impreza	Prodrive P1 (upgrade Alcon)	7700	0461
02-	Forester		0929	-
02-	Impreza	Non WRX / Sti	0929	-
02-	Outback		0929	-
12-	BRZ		0929	1124
<b>TOYOTA</b>				
83-87	Corolla	All AKE calipers	0282	-
94-98	Supra	Non Turbo	0619	0630
12-	GT86		0929	1124
<b>TVR</b>				
94-01	Cerbera	4.0, 4.2, 4.5, 5.0	7767	7720
01-	Cerbera	4.0, 4.2, 4.5	7869	0382
93-	Griffith	5.0, AP calipers	7767	0382
04-	Sagaris	4.0	7869	0382
02-	T350	4.0	7869	0382
01-	Tamora	3.6	7869	0382
01-	Tuscan	3.6, 4.0	7869	0382
<b>VAUXHALL</b>				
02-05	Monaro / VXR	5.7	0731	0413
<b>VOLKSWAGEN</b>				
98-	Bora	2.3 & 2.8	0687	0340
99-	Beetle	1.8 Turbo 20v	0687	0340
00-	Beetle	2.3 & 3.2 V6	0687	0340
<b>VOLVO</b>				
03-	S60 / S70 / V70	2.5 Turbo R	1001 / 7781	-





## PFC Pads for Competitors Kits

Competitors Pad Part No.	Caliper Pistons	Caliper Type	PFC Part Number
<b>AP Brake kits</b>			
CP3215D50	4 Piston	CP5200	7767
CP3345D44	4 Piston	CP5100	7740 / 7745
CP3894D51	6 Piston	CP5555	7793 / 1247
CP3894D54	6 Piston	CP5555	7795 (17mm)
CP5070D51	6 Piston	CP5570	7793 (17mm)
CP5070D54	6 Piston	CP5555	7790 (17mm)
CP6600D50	4 Piston	CP6600	7870
CP6600D55	4 Piston	CP6600	7869
CP7040D54	6 Piston	CP7040	7877
CP7600D44	4 Piston	CP7600	7834
CP7600D46	4 Piston	CP7600	Call for details
<b>Brembo Brake Kits</b>			
107.5146.31	4 Piston	(A) Family Type	0592
107.4865.80	4 Piston	(B) Family Type	7780
107.5146.13	4 Piston	(C) Family Type	0592
107.5146.13	4 Piston	(F) Family Type	0592
107.9312.44	8 Piston	(G) Family Type	7743
107.4865.80	4 Piston	(H) Family Type	7780
207.9551.13	6 Piston	(J) Family Type	Call for details
XA5.71.M2/XA5.71.M4	6 Piston	(M) Family Type	Call for details
XA5.71.L2/107.9551.13	6 Piston	(N) Family Type	Call for details
107.4865.80	4 Piston	(P) Family Type	7780
<b>Alcon Brake Kits</b>			
PNF4498x603	4 Piston	Mono Bloc	Call for details
PNF4497x607	6 Piston	Mono Bloc	7876
<b>Stoptech Brake Kits</b>			
	2 Piston	ST22	0109
	4 Piston	ST40	0447
	6 Piston	ST60	7793 / 1247
<b>K-Sport / D2 Brake Kits</b>			
	6 Piston	Front	7767
	8 Piston	Front	7790 (17mm)
	4 Piston	Rear	7745
	6 Piston	Rear	7745
<b>Hi-Spec Brake Kits</b>			
	2 piston	Ultralite	0109 / 7824
	4 Piston	Ultralite	0109 / 7824
	2 piston	Ultralite HB SVA	0051
	4 Piston	Monster	7767
	6 Piston	Monster	7767
	4 Piston	Mega Monster	7793 / 1247
	6 Piston	Mega Monster	7793 / 1247
	4 Piston	R114-4 Narrow Pad	7740
<b>Wilwood</b>			
	4 piston	Powerlite	7895
	4 piston	Dynalite w/ Bridgebolt	0421
	6 piston	GN III Caliper	7753
	4 piston	Billet Narrow Dynalite	7754
	4/6 piston	Superlite	7751





# PAD PROFILES

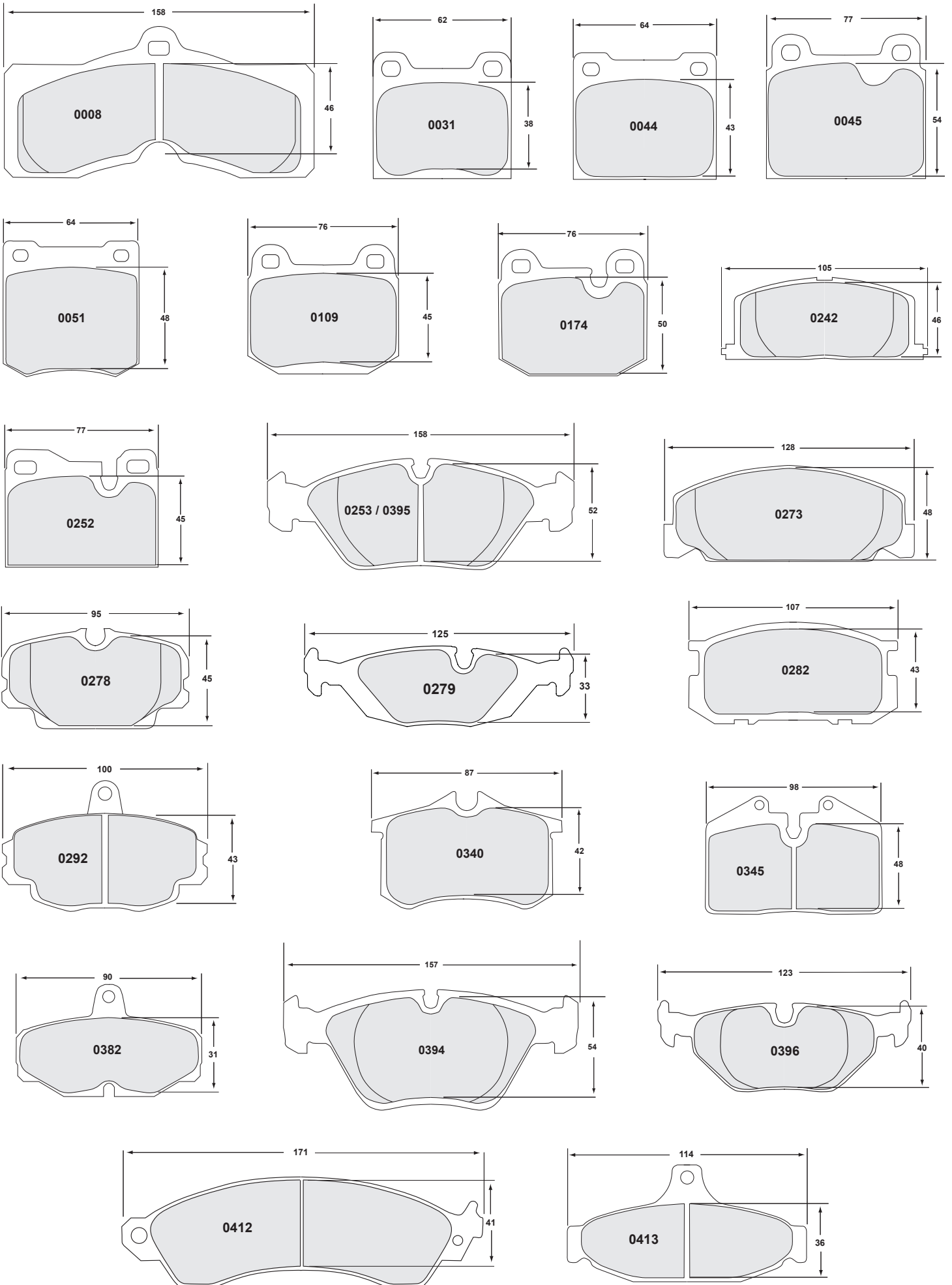

# PAD PROFILES

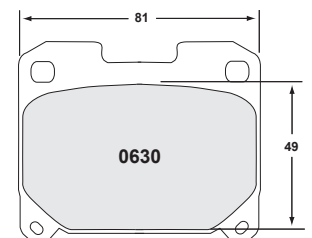
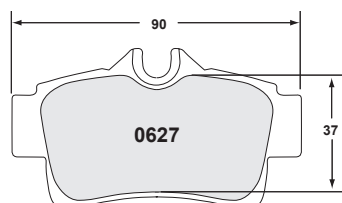
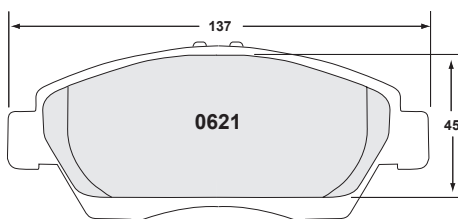
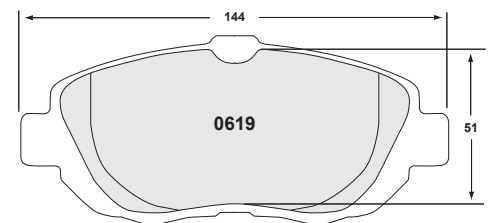
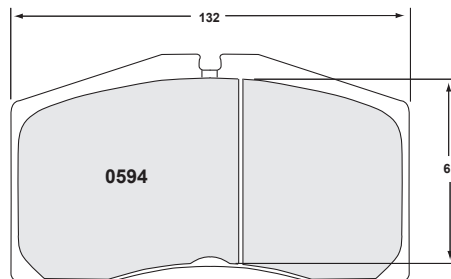
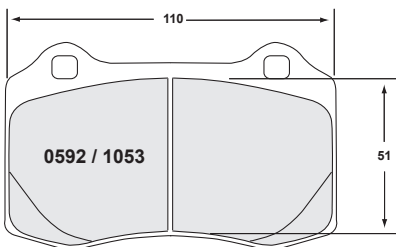
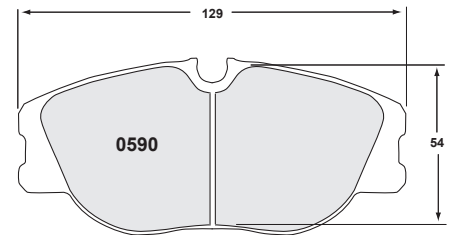
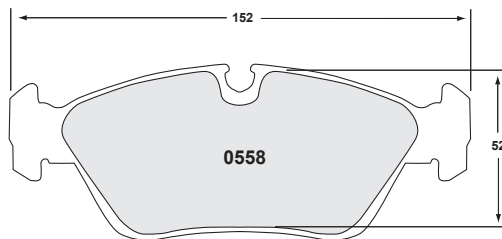
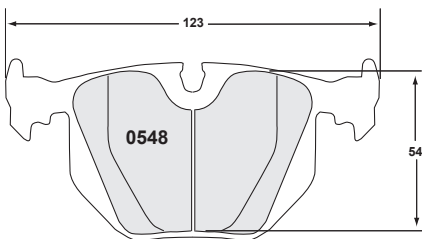
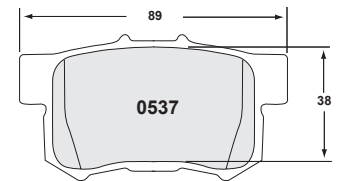
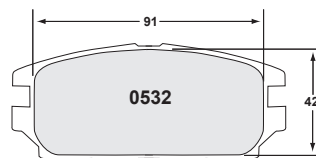
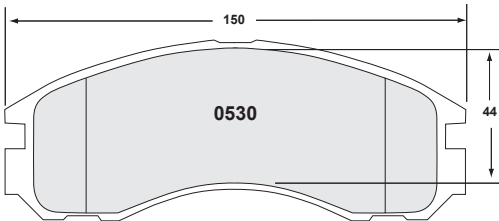
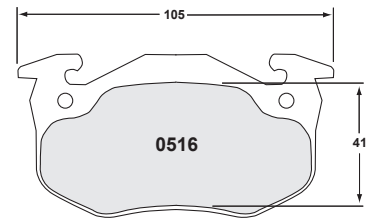
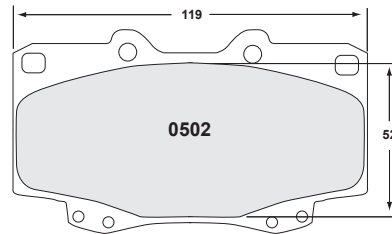
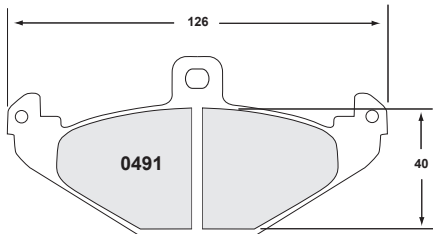
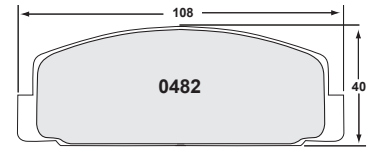
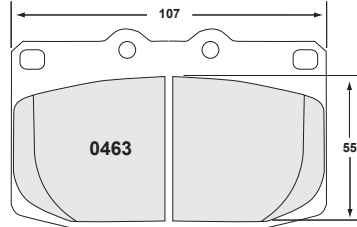
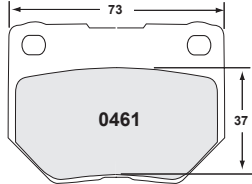
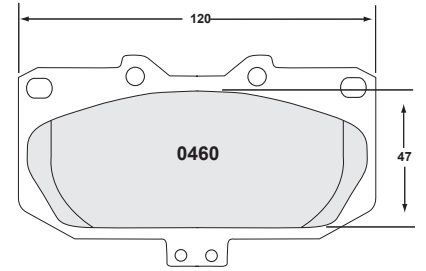
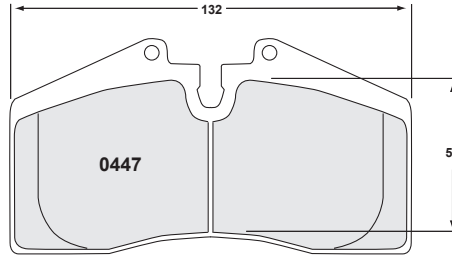
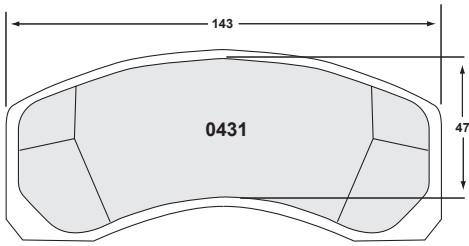

# PAD PROFILES

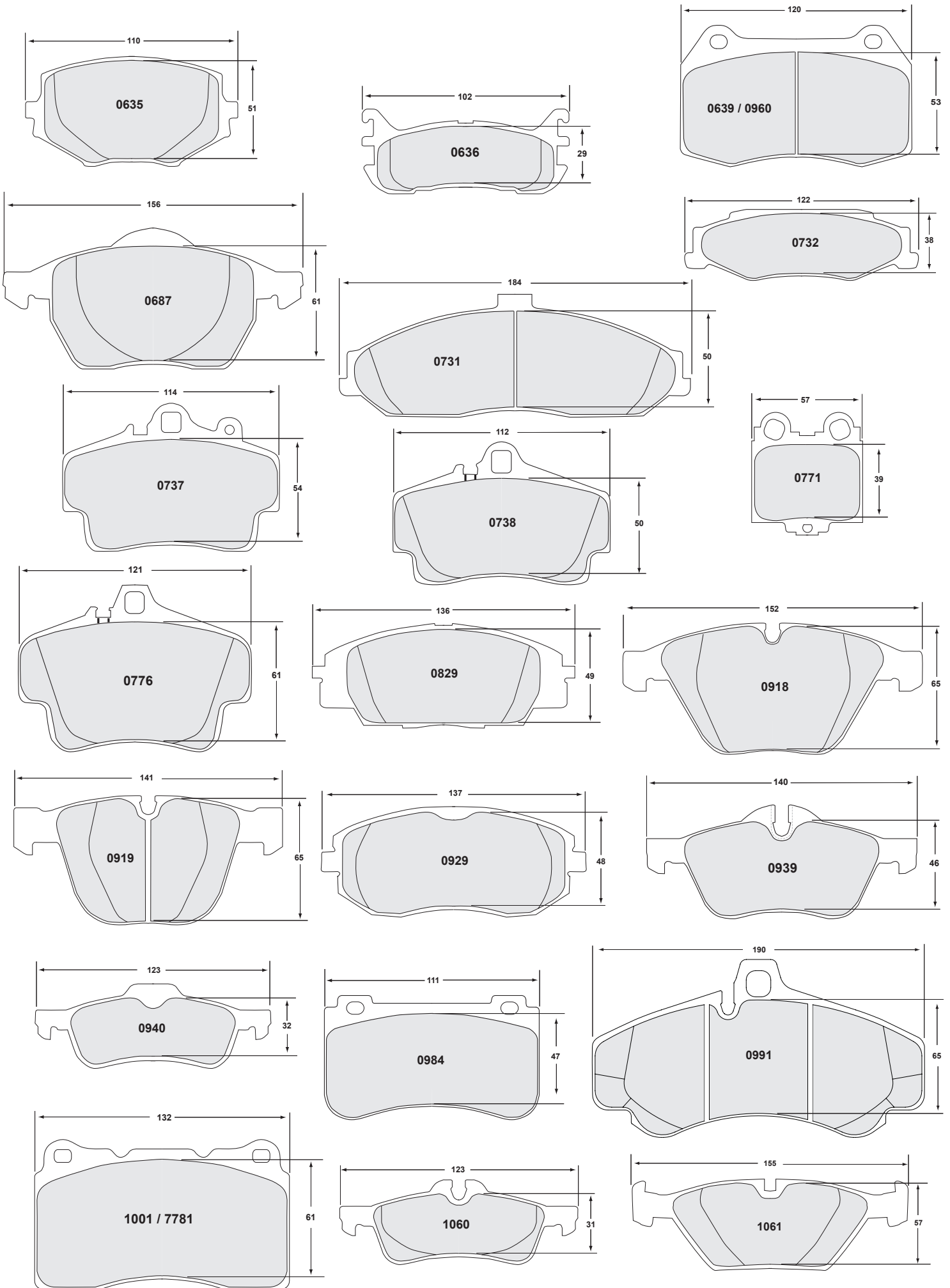

# PAD PROFILES

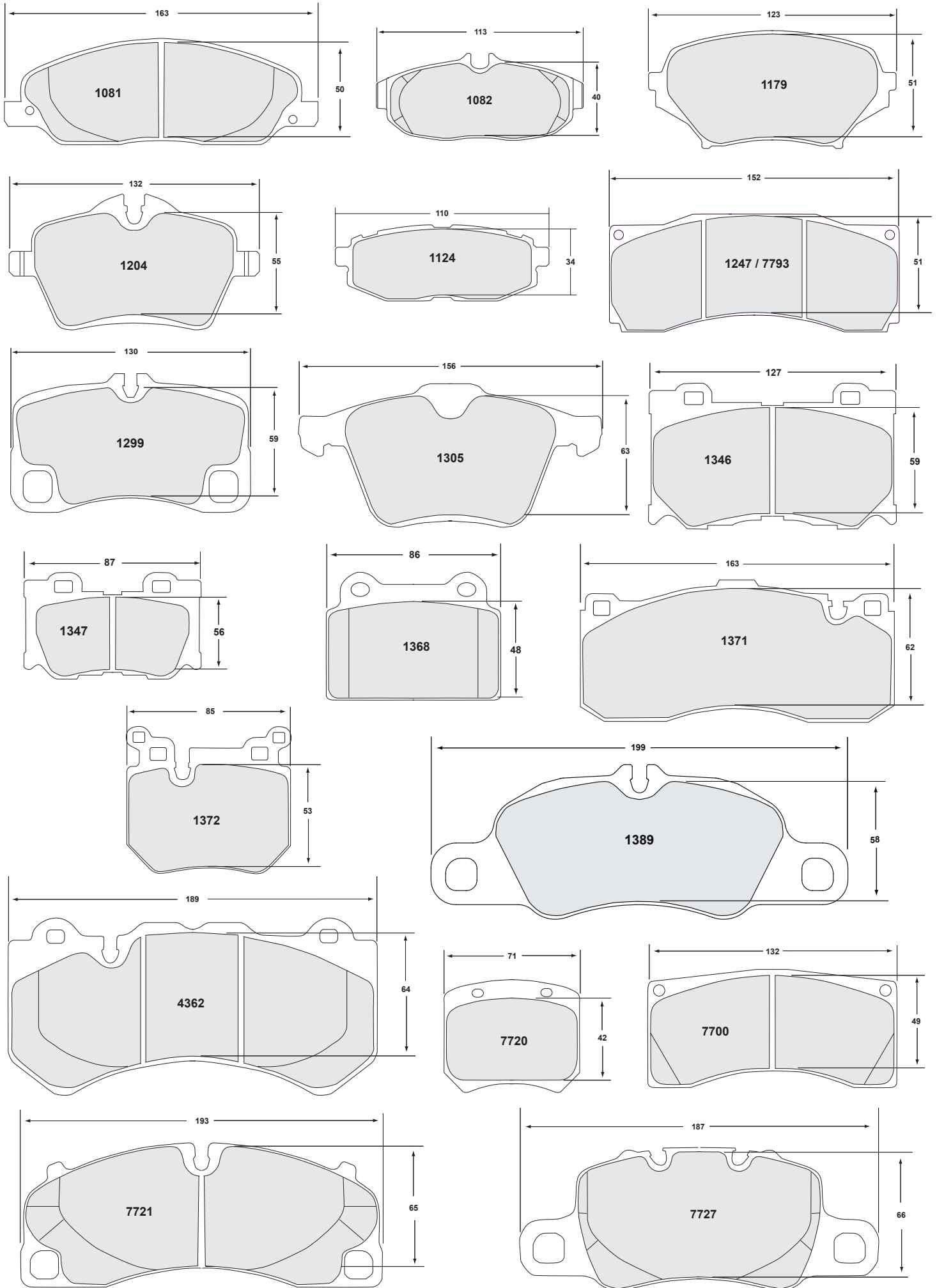

# PAD PROFILES

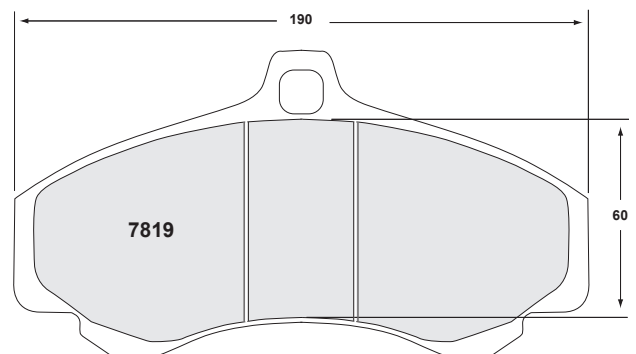
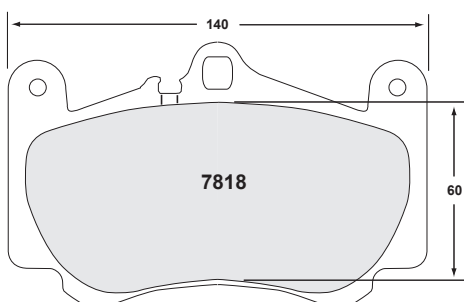
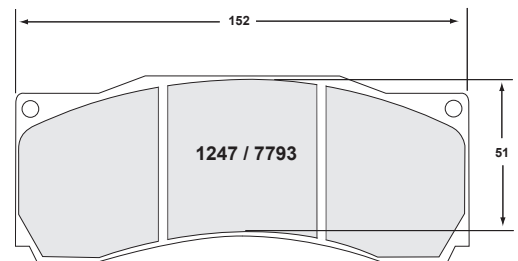
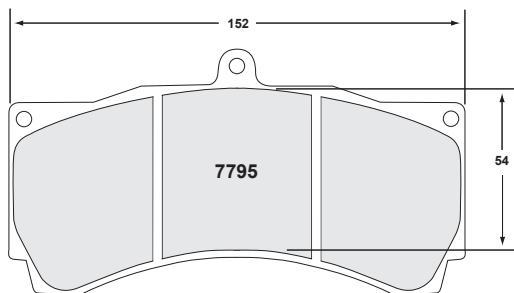
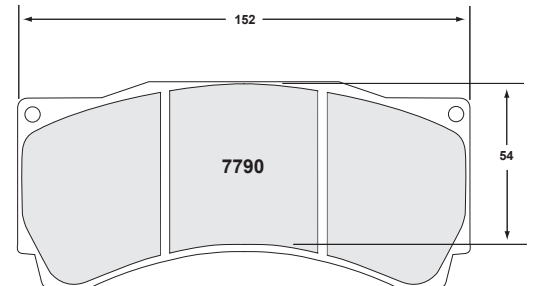
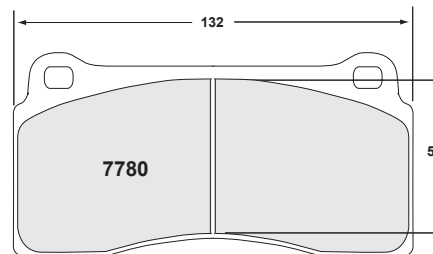
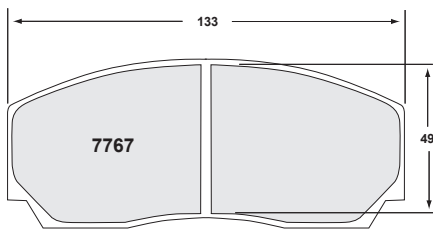
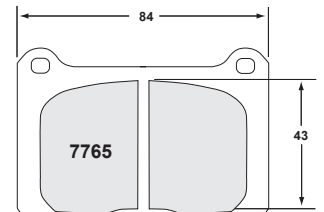
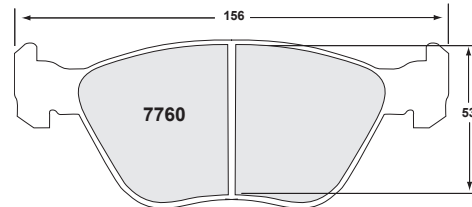
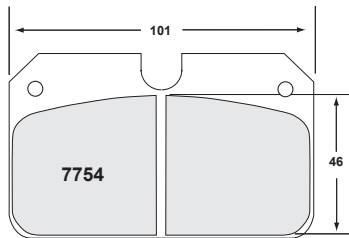
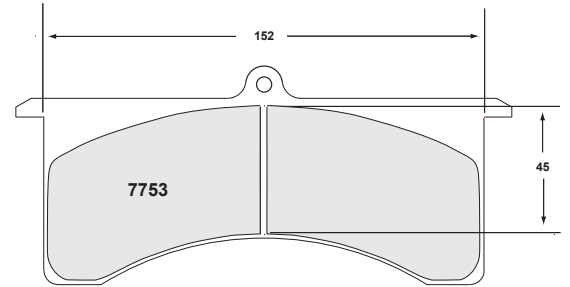
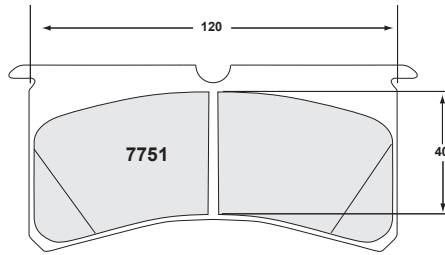
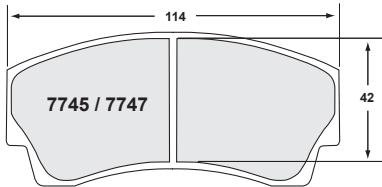
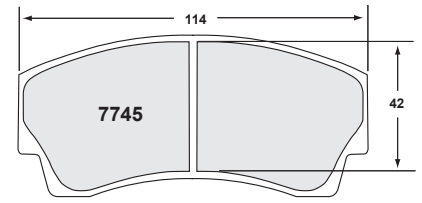
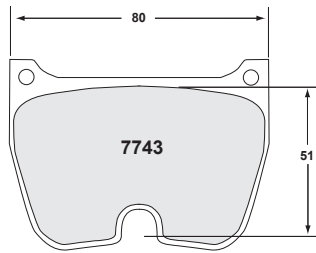
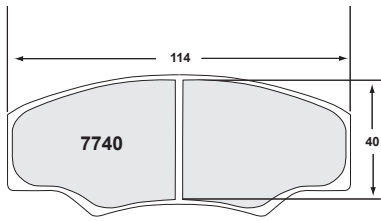

# PAD PROFILES

